

SPLIT SYSTEM AIR CONDITIONER INSTALLATION MANUAL

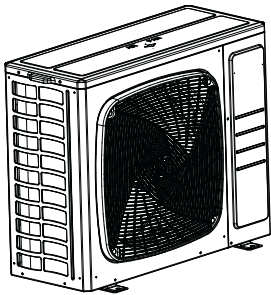

1U105S2SS1FA
1U105S2SS1FB
1U105S2SS2FA

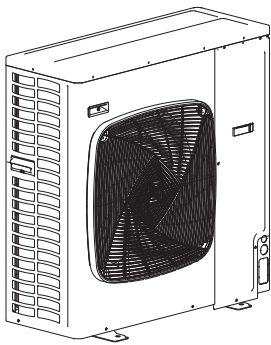

1U125S2SN1FA
1U125S2SN1FB
1U125S2SN2FA
1U125S2SN2FB
1U140S2SN1FA
1U140S2SN1FB

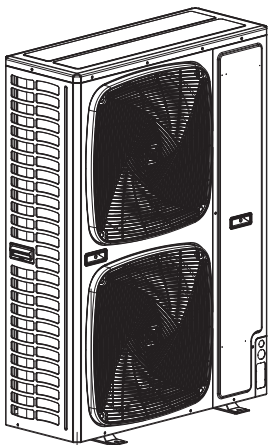

1U140S2SP1FA
1U140S2SP1FB
1U140S2SP2FA
1U140S2SP2FB
1U160S2SP1FB

No. 0150547787

- This product must only be installed or serviced by qualified personnel.
Please read this manual carefully before installation. This appliance is filled with R32.
Keep this manual for future reference.
Original instructions



SPLIT SYSTEM AIR CONDITIONER INSTALLATION MANUAL

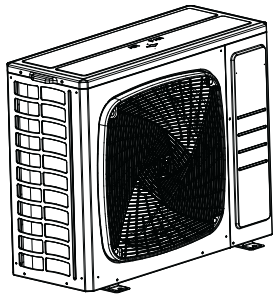

1U105S2SS1FA
1U105S2SS1FB
1U105S2SS2FA

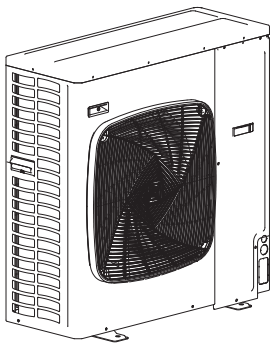

1U125S2SN1FA
1U125S2SN1FB
1U125S2SN2FA
1U125S2SN2FB
1U140S2SN1FA
1U140S2SN1FB

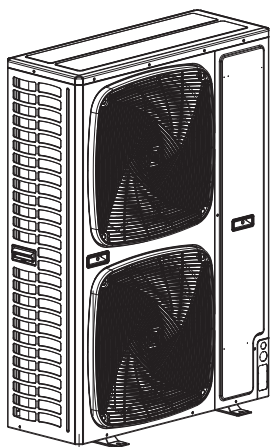

1U140S2SP1FA
1U140S2SP1FB
1U140S2SP2FA
1U140S2SP2FB
1U160S2SP1FB

Contents

Definitions	6
Safety considerations	6
Before installation	8
Selecting installation site	9
Precautions on installation.....	11
Refrigerant pipe size and allowable pipe length	12
Refrigerant piping	15
Leak test and vacuum drying	17
Charging refrigerant.....	18
Electrical wiring work	19
Test operation	21
Move and scrap the air conditioning....	25

- This product must only be installed or serviced by qualified personnel.
Please read this manual carefully before installation. This appliance is filled with R32.
Keep this manual for future reference.
Original instructions



Haier

Haier Industrial Park, Qianwangang Road, Eco-Tech Development Zone, Qingdao 266555, Shandong, P.R.C.

EUROPEAN REGULATIONS CONFORMITY FOR THE MODELS

CE

All the products are in conformity with the following European provision:

- Low voltage Directive
- Electromagnetic Compatibility

ROHS

The products are fulfilled with the requirements in the directive 2011/65/EU of the European parliament and of council on the Restriction of the use of Certain Hazardous Substances in Electrical and Electronic Equipment (EU RoHS Directive)

WEEE

In accordance with the directive 2012/19/EU of the European parliament, herewith we inform the consumer about the disposal requirements of the electrical and electronic products.

DISPOSAL REQUIREMENTS:



Your air conditioning product is marked with this symbol. This means that electrical and electronic products shall not be mixed with unsorted household waste. Do not try to dismantle the system yourself; the

dismantling of the air conditioning system, treatment of the refrigerant, of oil and of other part must be done by a qualified installer in accordance with relevant local and national legislation. Air conditioners must be treated at a specialized treatment facility for reuse, recycling and recovery. By ensuring this product is disposed of correctly, you will help to prevent potential negative consequences for the environment and human health. Please contact the installer or local authority for more information. Battery must be removed from the remote controller and disposed of separately in accordance with relevant local and national legislation.

IMPORTANT INFORMATION REGARDING THE REFRIGERANT USED

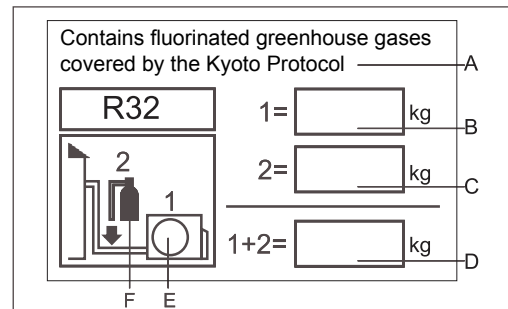

This product contains fluorinated greenhouse gases covered by the Kyoto Protocol. Do not vent into the atmosphere.

Refrigerant type: R32

GWP: 675

GWP = global warming potential

Please fill in with indelible ink,

- 1 the factory refrigerant charge of the product
- 2 the additional refrigerant amount charged in the field and
- 1+2 the total refrigerant charge

on the refrigerant charge label supplied with the product. The filled out label must be adhered in the proximity of the product charging port (e.g. onto the inside of the 2 stop value cover).

A contains fluorinated greenhouse gases covered by the Kyoto Protocol



B factory refrigerant charge of the product: see unit name plate

C additional refrigerant amount charged in the field

D total refrigerant charge

E outdoor unit

F refrigerant cylinder and manifold for charging

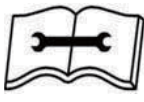
	Read the precautions in this manual carefully before operating the unit.		This appliance is filled with R32.
	Read the operator's manual		Service indicator, read technical manual

After reading this handbook, hand it over to those who will be using the unit.

The user of the unit should keep this manual at hand and make it available to those who will be performing repairs or relocating the unit. Also, make it available to the new user when the user changes hands.

WARNING

Ask your dealer or qualified personnel to carry out installation work. Do not attempt to install the air conditioner yourself. Improper installation may result in water leakage, electric shocks, fire or explosion. All the cables shall have got the European authentication certificate. During installation, when the connecting cables break off, it must be assured that the grounding wire is the last one to be broken off. If refrigerant gas leaks during installation, ventilate the area immediately. Oxidic gas may be produced. If the refrigerant comes into contact with fire, and explosion may be happen.

Make sure ground connection is correct and reliable. Do not earth the unit to a utility pipe, lightning conductor or telephone earth lead. Imperfect earthing may result in electric shocks.

The breaker of the air conditioner should be all-pole switch and explosion-proof. The distance between its two contacts should not be no less than 3mm. Such means for disconnection must be incorporated in the wiring.

The air conditioning sockets should be placed 1m above from the air conditioner, nor under the air conditioner. Be sure not to use open flame, high static electrical or high temperature equipments etc. nearby the air conditioner.

Do not use means to accelerate the defrosting process or to clean, other than those recommended by the manufacturer.

The appliance must be stored in a room without continuously operating ignition sources, the radius of the storage area should be no less than 2.5 m (for example: open flames, an operating gas appliance or an operating electric heater).

Do not pierce or burn.

Be aware that refrigerants may not contain an odour.

The appliance must be installed, operated and stored in a room with a floor area larger than the Minimum Room Area specified in the table on the following pages, The room should be well ventilated.

Comply with national gas regulations.

This appliance can be used by children aged 8 years and above and persons with reduced physical, sensory or mental capabilities or lack of experience and knowledge if they have been given supervision or instruction concerning use of the appliance in a safe way and understand the hazards involved. Children shall not play with the appliance. Cleaning and user maintenance shall not be made by children without supervision.

The air conditioner can not be discarded or scrapped Randomly If you need please contact customer service personnel of Haier to scrap in order to obtain the correct disposal methods.

Reusable mechanical connectors and flared joints are not allowed indoor.

CAUTION

Do not install the air conditioner at any place where there is danger of flammable gas leakage. In the event of a gas leakage, build-up of gas near the air conditioner may cause a fire to break out.

Tighten the flare nut according to the specified method such as with a torque wrench. If the flare nut is too tight, it may crack after prolonged use, causing refrigerant leakage.

Take adequate steps to prevent the outdoor unit being used as a shelter by small animals. Small animals making contact with electrical parts can cause malfunctions, smoke or fire.

Please instruct the customer to keep the area around the unit clean

The temperature of refrigerant circuit will be high, please keep the inter-unit wire away from copper pipes that not thermally insulated.

Only qualified personnel can handle, fill, purge and dispose of the refrigerant.

WARNING

If the supply cord is damaged, it must be replaced by the manufacturer, its service agent or similarly qualified persons in order to avoid a hazard.

This appliance is not intended for use by persons (including children) with reduced physical, sensory or mental capabilities, or lack of experience and knowledge, unless they have been given supervision or instruction concerning use of the appliance by a person responsible for their safety.

Children should be supervised to ensure that they do not play with the appliance.

This appliance can be used by children aged from 8 years and above and persons with reduced physical, sensory or mental capabilities or lack of experience and knowledge if they have been given supervision or instruction concerning use of the appliance in a safe way and understand the hazards involved. Children shall not play with the appliance. Cleaning and user maintenance shall not be made by children without supervision.

The appliances are not intended to be operated by means of an external timer or separate remote-control system.

Keep the appliance and its cord out of reach of children less than 8 years.

This appliance is intended to be used by expert or trained users in shops, in light industry and on farms, or for commercial use by lay persons.

Disconnect the appliance from its power source during maintenance service and when replacing parts.

1) Means for disconnection, such as circuit breaker, which can provide full disconnection in all poles, must be incorporated in the fixed wiring in accordance with the wiring rules.

It is necessary to allow disconnection of the appliance from the supply after installation. The disconnection may be achieved by incorporating a switch in the fixed wiring in accordance with the wiring rules.

The method of connection of the appliance to the electrical supply and interconnection of separate components, and the wiring diagram with a clear indication of the connections and wiring to external control devices and supply cord are detailed in below parts.

2) The appliance shall be installed in accordance with national wiring regulations. Wiring must be done by a qualified electrician. All the wiring must comply with the local electrical codes.

3) The cord of the H05RN-F type or the electrically equivalent type must be used for power connection and interconnection between outdoor unit and indoor unit. The size of the cord is detailed in below parts.

4) Details of type and rating of fuses, or rating of circuit breakers / ELB is detailed in below parts.

5) The information of dimensions of the space necessary for correct installation of the appliance including the minimum permissible distances to adjacent structures is detailed in below parts.

1. Definitions

1.1. Meaning of warnings and symbols

Warnings in this manual are classified according to their severity and probability of occurrence.

DANGER
 Indicates an imminently hazardous situation which, if not avoided, will result in death or serious injury.

WARNING
 Indicates a potentially hazardous situation which, if not avoided, could result in death or serious injury.

CAUTION
 Indicates a potentially hazardous situation which, if not avoided, may result in minor or moderate injury. It may also be used to alert against unsafe practices.

NOTICE
 Indicates situations that may result in equipment or property-damage accidents only.

INFORMATION
 This symbol identifies useful tips or additional information.

Some types of danger are represented by special symbols:

 Electric current.

 Danger of burning and scalding.

1.2. Meaning of used terms

Installation manual:

Instruction manual specified for a certain product or application, explaining how to install, configure and maintain it.

Operation manual:

Instruction manual specified for a certain product or application, explaining how to operate it.

Maintenance instructions:

Instruction manual specified for a certain product or application, which explains (if relevant) how to install, configure, operate and/or maintain the product or application.

Dealer:

Sales distributor for products as per the subject of this manual.

Installer

Technical skilled person who is qualified to install products as per the subject of this manual.

User:

Person who is owner of the product and/or operates the product.

Service company:

Qualified company which can perform or coordinate the required service to the unit.

Applicable legislation:

All international, European, national and local directives, laws, regulations and/or codes which are relevant and applicable for a certain product or domain.

Accessories:

Equipment which is delivered with the unit and which needs to be installed according to instructions in the documentation.

Optional equipment:

Equipment which can optionally be combined to the products as per the subject of this manual.

Field supply:

Equipment which needs to be installed according to instructions in this manual, but which are not supplied by Haier.

2. Safety considerations

The precautions here, all cover very important topics, so be sure to follow them carefully.

All activities described in this manual shall be carried out by an installer.

Be sure to wear adequate personal protection equipment (Protection gloves, safety glasses.....) when performing installation, maintenance or service to the unit.

If not sure of installation procedures or operation of the unit, always contact your local dealer for advice and information.

Improper installation or attachment of equipment or accessories could result in electric shock, short-circuit, leaks, fire or other damage to the equipment. Be sure only to use accessories, optional equipment and spare parts made by which are specially designed for use with the products as of subject in this manual and have them installed by an installer.



DANGER: ELECTRICAL SHOCK

Switch off all power supply before removing the switch box service panel or before making any connections or touching electrical parts.

To avoid electric shock, be sure to disconnect the power supply 2 minute or more before servicing the electrical parts. Even after 2 minute, always measure the voltage at the terminals of main circuit capacitors or electrical parts. Even after 2 minute, always measure the voltage at the terminals of main circuit capacitors or electrical parts, and before touching, be sure that those voltages are 50V DC or less.

When service panels are removed, live parts can easily be touched by accident, Never leave the unit unattended during installation or servicing when the service panel is removed.



DANGER: DO NOT TOUCH PIPING AND INTERNAL PARTS

Do not touch the refrigerant piping, water piping or internal parts during and immediately after operation. The piping and internal parts may be hot or cold depending on the working condition of the unit.

Your hand may suffer burns or frostbite if you touch the piping or internal parts. To avoid injury, give the piping and internal parts time to return to normal temperature or, if you must touch them, be sure to wear protective gloves

Warning:

- Ask your dealer or qualified personnel to carry out installation work. Do not install the machine by yourself. Improper installation may result in water leakage, electric shocks or fire.
- Perform installation work in accordance with this installation manual.
- Improper installation may lead to water leakage, electric shocks or fire.
- The equipment is not intended for use in a potentially explosive atmosphere.
- For **1U series** units only.
- For year round cooling applications with low indoor humidity conditions, such as Electronic Data Processing rooms, contact your dealer or see the engineering databook or the service manual.
- Consult your local dealer regarding what to do in case of refrigerant leakage. When the unit is to be installed in a small room, it is necessary to take proper measures so that the amount of any leaked refrigerant does not exceed the concentration limit in the event of a leakage. Otherwise, this may lead to an accident due to oxygen depletion.
- Be sure to use only the specified accessories and parts for installation work.
- Failure to use the specified parts may result in water leakage, electric shocks, fire, or the unit falling.
- Install the unit on a foundation that can withstand its weight.
- Insufficient strength may result in the fall of equipment and causing injury.
- Carry out the specified installation work in consideration of strong winds, typhoons, or earthquakes.
- Improper installation work may result in accidents due to fall of equipment.
- Make sure that all electrical work is carried out by qualified personnel according to the applicable legislation and this installation manual, using a separate circuit.
- Insufficient capacity of the power supply circuit or improper electrical capacity of the power supply circuit or improper electrical construction may lead to electric shocks or fire.
- Make sure that all wiring is secure, using the specified wires and ensuring that external forces do not act on the terminal connections or wires.
- Incomplete connection or fixing may cause a fire.
- When wiring between the indoor and outdoor units, and wiring the power supply, form the wires so that the frontside panel can be securely fastened.
- If the frontside panel is not in place, overheating of the terminals, electric shocks or a fire may be caused.
- If refrigerant gas leaks during installation work, ventilate the area immediately.
- Toxic gas may be produced if refrigerant gas comes into contact with fire.
- After completing the installation work, check to make sure that there is no leakage of refrigerant gas.
- Toxic gas may be produced if refrigerant gas leaks into the room and comes into contact with a source of fire, such as a fan heater, stove or cooker.
- When planning to relocate former installed units, you must first recover the refrigerant after the pump down operation.
- Never directly touch any accidental leaking refrigerant. This could result in severe wounds caused by frostbite. Be sure to install an earth leakage circuit breaker in accordance with applicable legislation. Failure to do so may cause electrical shock and fire.

Caution:

- Earth the unit.
Earthing resistance should be according to applicable legislation.
Do not connect the earth wire to gas or water pipes, lightning conductor or telephone earth wire. 
Incomplete earthing may cause electric shocks.
- Gas pipe.
Ignition or explosion may occur if the gas leaks. Water pipe.
Hard vinyl tubes are not effective earths. Lightning conductor or telephone earth wire. Electric potential may rise abnormally if struck by a lightning bolt.
- Install drain piping according to this installation manual to ensure good drainage, and insulate the pipe to prevent condensation.
Improper drain piping may cause water leakage, and make the furnitures get wet.
- Install the indoor and outdoor units, power wire and connecting wire at least 1 meter away from televisions or radios to prevent image interference or noise. (Depending on the radio waves, a distance of 1 meter may not be sufficient to eliminate the noise.)
- Do not rinse the outdoor unit, This may cause electric shocks or fire.
- Do not install the unit in places such as the following:
 - Where there is mist of mineral oil, oil spray or vapour for example a kitchen.
Plastic parts may deteriorate, and cause them to fall out or water to leak.

- Where corrosive gas, such as sulphurous acid gas, is produced.
Corrosion of copper pipes or soldered parts may cause the refrigerant to leak.
- Where there is machinery which emits electromagnetic waves.
Electromagnetic waves may disturb the control system, and cause malfunction of the equipment.
- Where flammable gases may leak, where carbon fiber or ignitable dust is suspended in the air or where volatile flammables, such as thinner or gasoline, are handled. Such gases may cause a fire.
- Where the air contains high levels of salt such as that near the ocean.
- Where voltage fluctuates a lot, such as in factories.
- In vehicles or vessels.
- Where acidic or alkaline vapour is present.
- Do not allow a child to mount on the outdoor unit or avoid placing any object on the unit. Falling or tumbling may result in injury.
The unit may stop for several minutes during normal operation for "defrosting the unit", or when in "thermostat stop" operation.
- This appliance is intended to be used by expert or trained users in shops, in light industry and on farms, or for commercial use by lay persons.

Provide a logbook

In accordance with the relevant national and international codes, it may be necessary to provide a logbook with the equipment containing at least

- info on maintenance.
- repair work,
- results of tests,
- stand-by periods,
- etc...

In Europe, EN378 provides the necessary guidance for this logbook.

3. Before installation

3.1. Scope of this manual

This manual describes the procedures for handling, installing and connecting 1U105~160 units.

3.2 Precautions



CAUTION

Since maximum working pressure is 4.3 MPa or 43.0 bar, pipes of larger wall thickness may be required. Refer to paragraph "6.2. Selection of piping material" on page 10.



NOTICE: Insulation resistance of the compressor

If, after installation, refrigerant accumulates in the compressor, the insulation resistance can drop, but if it is at least 1 , then the machine will not break down. Turn the power on and leave it on for six hours. Then, check if the insulation resistance of the compressor has risen or not.

The compressor will heat up and evaporate any refrigerant in the compressor.

Check the following if the ground-fault circuit interrupter is triggered:

Make sure that the interrupter is compatible with high frequencies.

This unit has an inverter, so an interrupter capable of handling high frequencies is needed to prevent malfunction of the interrupter itself.

3.3. Precautions for R32

- The refrigerant requires strict cautions for keeping the system clean, dry and tight.
 - Clean and dry
 Foreign materials (including mineral oils or moisture) should be prevented from getting mixed into the system.
 - Tight

Read "9. Precautions on refrigerant piping" on page 10 carefully and follow these procedures correctly.

- Since R32 is a mixed refrigerant, the required additional refrigerant must be charged in its liquid state. (If the refrigerant is in state of gas, its composition changes and the system will not work properly).
The connected indoor units must be indoor units designed exclusively for R32.

3.4. Installation

- For installation of the indoor unit(s), refer to the indoor unit installation manual.
- Illustrations show 1U140S2SP1FA outdoor unit type. Other types also follow this installation manual.
- This outdoor unit requires the pipe branching kit(optional) when used as the outdoor unit for the simultaneous operation system. Refer to catalogues for details.
- Never operate the unit with a damaged or disconnected discharge thermistor and suction thermistor, burning of the compressor may occur.
- Be sure to confirm the model name and the serial no. of the outer(front) plates when attaching/detaching the plates to avoid mistakes.
- When closing the service panels, take care that the tightening torque does not exceed 4.1 N.M.

3.5 Accessories

Check if the following accessories are included with the unit:
See the figure below for the location of the accessories.

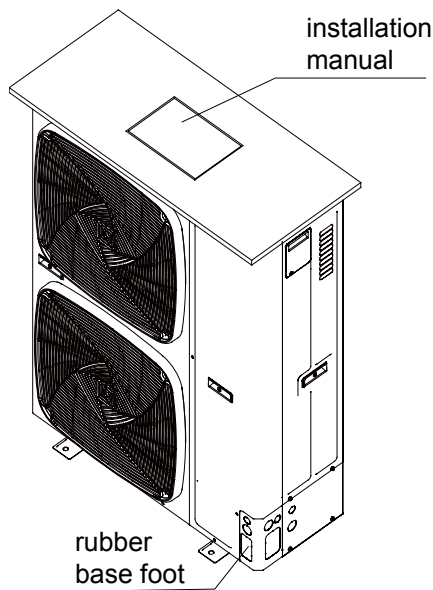

4. Selecting installation site

4.1. General



WARNING

- Be sure to provide for adequate measures in order to prevent that the outdoor unit be used as a shelter by small animals.
Small animals making contact with electrical parts can cause malfunctions, smoke or fire. Please instruct the customer to keep the area around the unit clean.
- Select an installation site where the following conditions are satisfied and that meets with your customer's approval.
 - Places which are well-ventilated.
 - Places where the unit does not bother next-door neighbours.
 - Safe places which can withstand the unit's weight and vibration and where the unit can be installed level.
 - Places where there is no possibility of flammable gas or product leak.
 - The equipment is not intended for use in a potentially explosive atmosphere.
 - Places where servicing space can be well ensured.
 - Places where the indoor and outdoor units's piping and wiring lengths come within the allowable ranges.
 - Places where water leaking from the unit cannot cause damage to the location (e.g. in case of a blocked drain pipe)
 - Places where the rain can be avoided as much as possible.
 - Do not install the unit in places often used as work place. In case of construction works (d.g. grinding works) where a lot of dust is created, the unit must be covered.
 - Do not place any objects or equipment on top of the unit (top plate).

- Do not climb, sit or stand on top of the unit.
- Be sure that sufficient precautions are taken, in accordance with applicable legislation, in case of refrigerant leakage.



NOTICE

This is a class A product. In a domestic environment this product may cause radio interference in which case the user may be required to take adequate measures.

- When installing the unit in a place exposed to strong wind, pay special attention to the following.
Strong winds of 5 m/sec or more blowing against the outdoor unit's air outlet causes short circuit (suction of discharge air), and this may have the following consequences:
 - Deterioration of the operational capacity.
 - Frequent frost acceleration in heating operation.
 - Disruption of operation due to rise of high pressure.
 - When a strong wind blows continuously on the face of the unit, the fan can start rotating very fast until it breaks.Refer to the figures for installation of this unit in a place where the wind direction can be foreseen.
- Repair a water drainage channel around the foundation, to drain waste water from around the unit.
- If the water drainage of the unit is not easy, please build up the unit on a foundation of concrete blocks, etc. (the height of the foundation should be maximum 150mm).
- If you install the unit on a frame, please install a waterproof plate (field supply) within 150mm of the underside of the unit in order to prevent the invasion of water from the lower direction.
When installing the unit in a place frequently exposed to snow, pay special attention to elevate the foundation as high as possible.
- Make sure that the unit is installed level.

4.2. General



NOTICE

When operating the outdoor unit in a low outdoor ambient temperature, be sure to follow the instructions described below.

- To prevent exposure to wind, install the outdoor unit with its suction side facing the wall.
- Never install the outdoor unit at a site where the suction side may be exposed directly to wind.
- To prevent exposure to wind, install a baffle plate on the air discharge side of the outdoor unit.
In heavy snowfall areas it is very important to select an installation site where the snow will not affect the unit and set the outlet side at a right angle to the direction of the wind.

4.3 General

- For seacoast applications, block the unit from direct exposure to sea breeze by installing the unit behind a structure (such as a building) or a protective wall that is 1.5 times higher than the unit, leaving 700 mm of space between the wall and unit for air circulation. Consult an installation expert about taking anti-corrosion measures, such as removing salinity on the heat exchanger and applying a rust inhibitor more frequently than once a year.

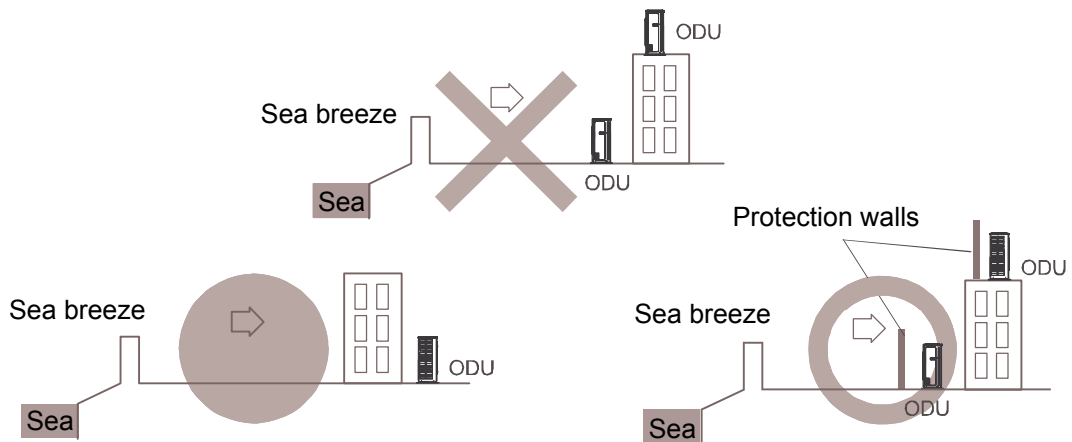

- Set the unit on mounting brackets or pad. To avoid the adverse effects of snow, ice and defrosting issues, install the unit on heat pump risers to ensure a sufficient height from the ground. In all cases, refer to local code for correct riser height.

Make sure the outdoor unit is installed level and is stable.

Install snow protection hood as necessary.

Correct installation

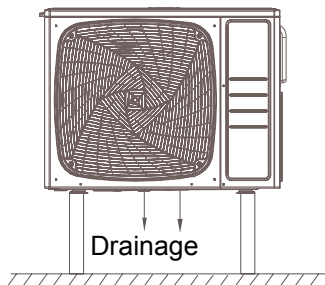

Wrong installation

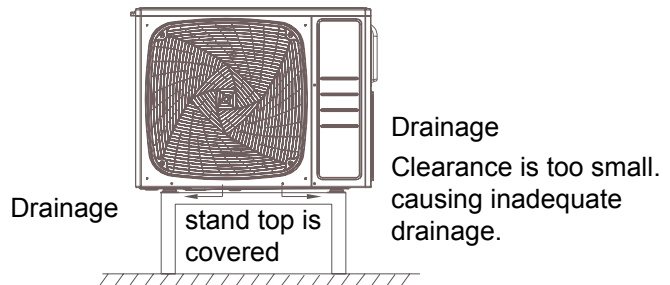

Correct installation

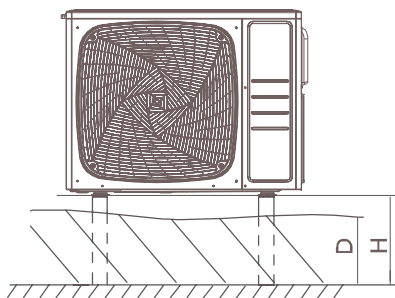

Minimum height (H) should be higher than the highest snowfall depth (D) ($H=D+20\text{cm}$)

Wrong installation

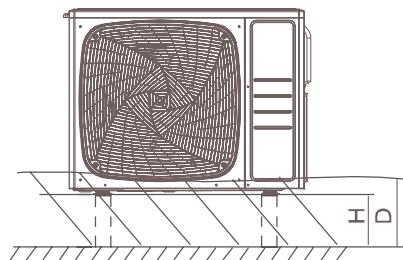

unit may become covered in snow if the stand height is insufficient.

5. Precautions on installation

NOTICE

If drain holes of the outdoor unit are covered by a mounting base or by floor surface, raise the unit in order to provide a free space of more than 130mm under the outdoor unit.

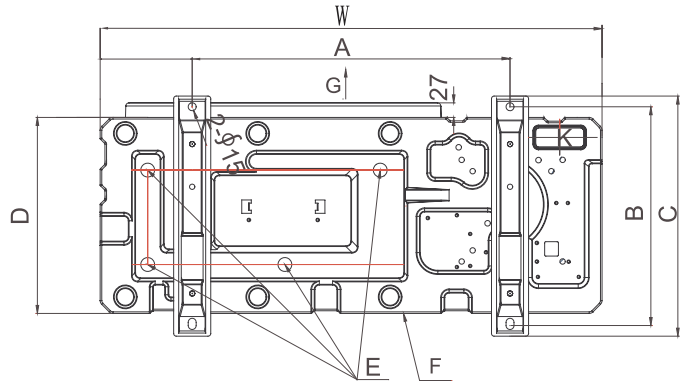
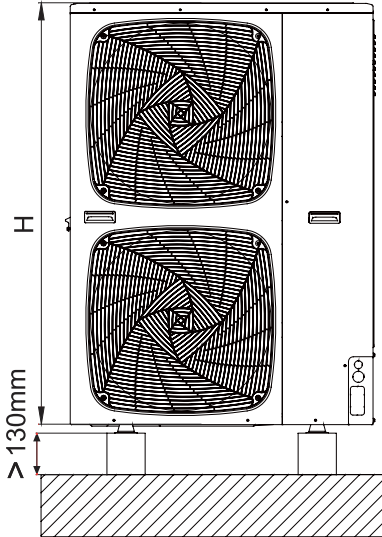

- A leg pitch1
- B leg pitch2
- C Front grill (air outlet side)
- D Drain hole
- E Bottom frame
- K Knock-out hole (for piping line)

	1U105	1U125 1U140 N1	1U140 P1/2 1U160 P1
A	660	600	600
B	400-405	405-410	405-410
C	434	450	450
D	368	368	368
W	917	950	950
H	758	965	1350

5.2. Selection of installation location of outdoor

(1) Single-unit installation (unit: mm)

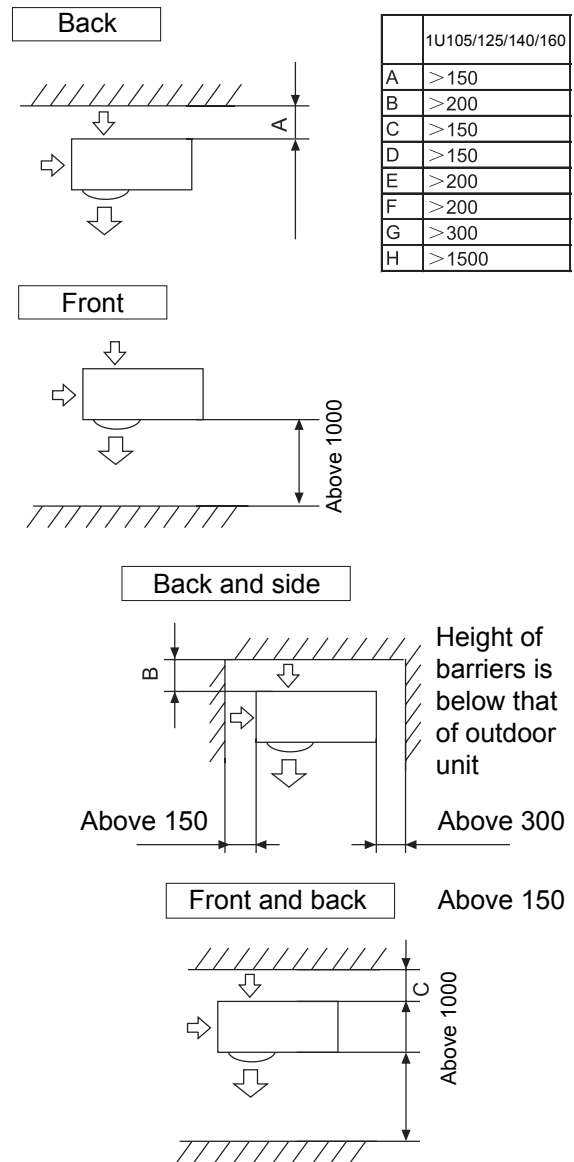

5.1 Foundation work

- Check the strength and level of the installation ground so that the unit will not cause any operating vibration or noise after installation.
- In accordance with the foundation drawing in the figure, fix the unit securely by means of the foundation bolts. (Prepare four sets of M12 foundation bolts, nuts and washers each which are available on the market.)
- It is best to screw in the foundation bolts until their length are 20mm from the foundation surface.

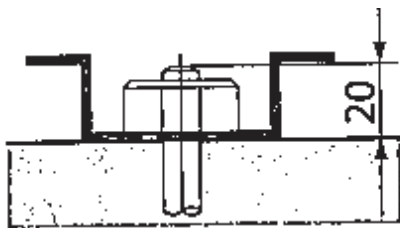

- Fix the outdoor unit to the foundation bolts using nuts with resin washers(1) as shown in the figure.

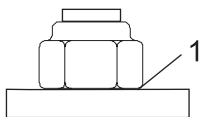

If the coating on the fastening area is stripped off, the nuts rust easily.

Dimensions (bottom view)(unit of measurement:mm)

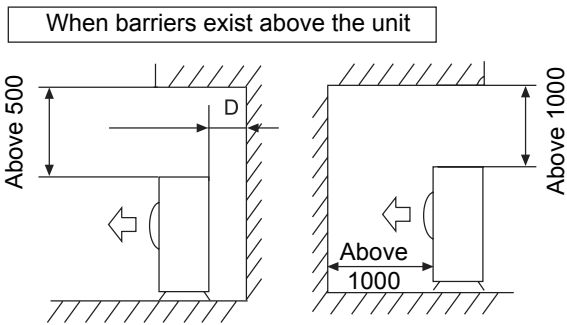

The top and two side surfaces must be exposed to open space, and barriers on at least one side of the front and back shall be lower than the outdoor unit.

(2) Multi-unit installation (unit: mm)

Back and side

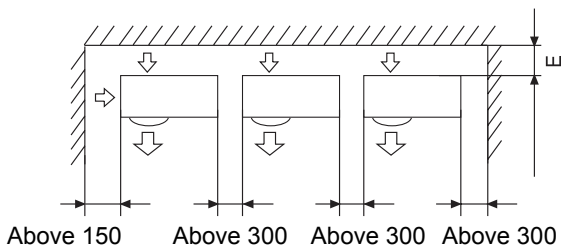

Front and back

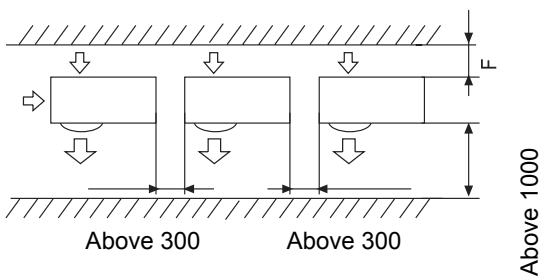

Height of barriers is below that of outdoor unit

(3) Multi-unit installation in front and back (unit: mm)
Standard

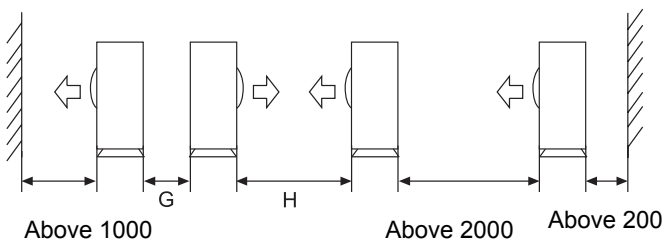

The top and two side surfaces must be exposed to open space, and barriers on at least one side of the front and back shall be lower than the outdoor unit.

- The installation service spaces shown in the illustrations are based on an air intake temperature of 35 (DB) for COOL operation. In regions where the air intake temperature regularly exceeds 35 (DB), or if the heat load of outdoor units is expected to regularly exceed the maximum operating capacity, reserve a larger space than that indicated at the air intake side of units.

- Regarding the required air outlet space, position the units with consideration to the space required for the onsite refrigerant piping work as well. Consult your dealer if the work conditions do not match those in the drawings.

5.3. Drain pipe disposal

- Make sure the drain works properly.
- In regions where buildups of snow can be expected, the accumulation and freezing of snow in the space between the heat exchanger and external plate may lower operating efficiency.
- After punching the knock-out hole, the application of repair-type paint on the surface around the edge sections is recommended to prevent rust.

6. Refrigerant pipe size and allowable pipe length

! DANGER

- Piping an other pressure containing parts shall comply with the applicable legislation and shall be suitable for refrigerant. Use phosphoric acid deoxidised seamless copper for refrigerant.
- Installation shall be done by an installer, the choice of materials and installation shall comply with applicable legislation. In Europe the EN378 is the application standard that shall be used.

! INFORMATION

It is forbidden to discharge refrigerant into the atmosphere. Collect the refrigerant in accordance with the freon collection and destruction law.

! NOTICE

To persons in charge of piping work:
Be sure to open the stop valve after piping installing and vacuuming is complete. (Running the system with the valve closed may break the compressor.)

i NOTICE

Do not use flux when brazing the refrigerant piping. For brazing, use phosphor copper brazing filler metal (BCuP) which does not require a flux. (If a chlorine flux is used, the piping will corrode, and if the flux contains fluoride, it will cause the coolant oil to deteriorate, adversely affecting the coolant piping system.)

6.1. Necessary Tools and Materials

Prepare the following tools and materials necessary for installing and servicing the unit.

Necessary tools for use with R410A/R32(Adaptability of tools that are for use with R22 and R407C).

1. To be used exclusively with R410A/R32 (Not to be used if used with R22 or R407C)

Tools/Materials	Use	Notes
Gauge Manifold	Evacuating,refrigerant charging	5.09MPa on the High-pressure side.
Charging Hose	Evacuating, refrigerant charging	Hose diameter larger than the conventional ones.
Refrigerant Recovery Equipment	Refrigerant recovery	
Refrigerant Cylinder	Refrigerant charging	Write down the refrigerant type. Pink in color at the top of the cylinder.
Refrigerant Cylinder Charging Port	Refrigerant charging	Hose diameter larger than the conventional ones.
Flare Nut	Connecting the unit to piping	Use Type-2 Flare nuts.

2. Tools and materials that may be used with R410A/R32 with some restrictions

Tools/Materials	Use	Notes
Gas leak detector	Detection of gas leaks	The ones for HFC type refrigerant may be used.
Vacuum Pump	Vacuum drying	May be used if a reverse flow check adaptor is attached.
Flare Tool	Flare machining of piping	Changes have been made in the flare machining dimension. Refer to the next page.
Refrigerant Recovery Equipment	Recovery of refrigerant	May be used if designed for use with R410A.

3. Tools and materials that are used with R22 or R407C that can also be used with R410A/R32

Tools/Materials	Use	Notes
Vacuum Pump with a Check Valve	Vacuum drying	
Bender	Bending pipes	
Torque Wrench	Tightening flare nuts	Only Ø12.70 (1/2") and Ø15.88(5/8") have a larger flare machining dimension.
Pipe Cutter	Cutting pipes	
Welder and Nitrogen Cylinder	Welding pipes	
Refrigerant Charging Meter	Refrigerant charging	
Vacuum Gauge	Checking vacuum degree	

4. Tool and materials that must not used with R410A/R32

Tools/Materials	Use	Notes
Charging Cylinder	Refrigerant Charging	Must not be used with R410-type units.

Tools for R410A/R32 must be handled with special care, and keep moisture and dust from entering the cycle.

6.2. Piping Materials

6.2 Types of Copper Pipes (Reference)

Maximum Operation Pressure	Applicable Refrigerants
3.4MPa	R22, R407C
4.15MPa	R410A
4.3MPa	R32

- Use pipes that meet the local standards.

Piping Materials|Radial Thickness

Use pipes made of phosphorus deoxidized copper.

Since the operation pressure of the units that use R410A is higher than that of the units for use with R22, use pipes with at least the radial thickness specified in the chart below. (Pipes with a radial thickness of 0.7mm or less may not be used.)

Size(mm)	Size(inch)	Radial Thickness(mm)	Type
Φ 6.35	1/4"	0.8t	Type-O pipes
Φ 9.52	3/8"	0.8t	
Φ 12.7	1/2"	0.8t	
Φ 15.88	5/8"	1.0t	
Φ 19.05	3/4"	1.0t	Type-1/2H or Hpipes

- Although it was possible to use type-O for pipes with a size of up to Φ19.05(3/4") with conventional refrigerants, use type- 1/2H pipes for units that use R410A. (Type-O pipes may be used if the pipe size is Φ19.05 and the radial thickness is 1.2t.)
- The table shows the standards in Japan. Using this table as a reference, choose pipes that meet the local standards.

Flare Machining (type-O and OL only)

The flare machining dimensions for units that use R410A is larger than those for units that use R22 in order to increase air tightness.

Flare Machining Dimension(mm)

External dimension of pipes	Size	Dimension A	
		R410A	R22
Φ 6.35	1/4"	9.1	9.0
Φ 9.52	3/8"	13.2	13.0
Φ 12.7	1/2"	16.6	16.2
Φ 15.88	5/8"	19.7	19.4
Φ 19.05	3/4"	24.0	23.3

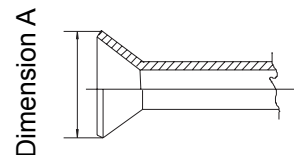

If a clutch type flare tool is used to machine flares on units that use R410A, make the protruding part of the pipe between 1.0 and 1.5mm. Copper pipe gauge for adjusting the length of pipe protrusion is useful.

Flare Nut

Type-2 flare nuts instead of type-1 nuts are used to increase the strength. The size of some of the flare nuts have also been changed.

Flare nut dimension(mm)

External dimension of pipes	Size	Dimension B	
		R410A(Type2)	R22(Type1)
Φ 6.35	1/4"	17.0	17.0
Φ 9.52	3/8"	22.0	22.0
Φ 12.7	1/2"	26.0	24.0
Φ 15.88	5/8"	29.0	27.0
Φ 19.05	3/4"	36.0	36.0

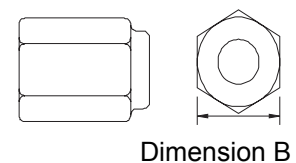

Using this table as a reference, choose pipes that meet the local standards.



NOTICE

- For new installations, use the standard pipe sizes. When using existing pipes, size-up is allowed as mentioned in the table above. Additional restrictions towards allowable pipe lengths, as mentioned in the table 7.3 on page 13, must be taken into account. Not using the standard lpipe size may result in capacity decrease. The installer must acknowledge this and judge this very carefully in function of the complete installation.
- Existing or pre-installed piping can be used
 - Piping must comply with the criteria below.
 - Piping diameter must comply with the limitations as indicated in paragraph "7.2. Refrigerant pipe size".
 - Piping length must be within limits of the allowable piping length as in paragraph "7.3. Allowable pipe length and height difference".
 - Piping must be designed for R410A. See paragraph "6.2. Selection of piping material".

- Piping can be reused without cleaning when:
 - Total 1-way piping length: $\leq 50\text{m}$.
 - No compressor breakdown has occurred in the history of the unit to be replaced.
 - A correct pump down operation can be executed:
 - Operate the unit continuously for 30 minutes in cooling mode.
 - Execute a pump down operation.
 - Remove the air conditioning units to be replaced.
 - Check the contamination inside the existing piping. If you cannot meet all these requirements, the existing pipes must be cleaned or replaced after removing the air conditioning units to be replaced.
- Prepare the flare connections for higher pressure. See paragraph 6.2

Cautions on handling the stem cap

- The stem cap is sealed where indicated by the arrow. Take care not to damage it. After handling the stop valve, make sure to tighten the stem cap securely. For the tightening torque, refer to the table below. Check for refrigerant leaks after tightening the stem cap.

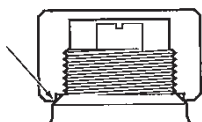

Cautions on handling the service port

- Always use a charge hose equipped with a valve depressor pin, since the service port is a Schrader type valve.
- After handling the service port, make sure to tighten the service port cap securely. For the tightening torque, refer to the table below.
- Check for refrigerant leaks after tightening the service port cap.

7. Refrigerant piping

7.1. Piping diagram for single split

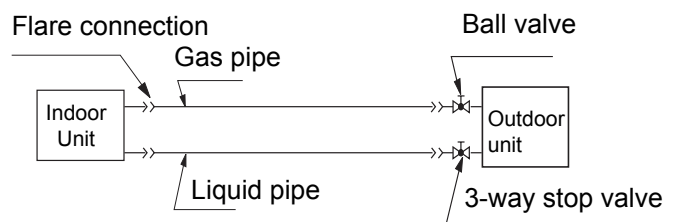

7.2. Piping size for single split

Model	Pipe	Diameter of pipe	connecting method
1U105S2SS1FA/B 1U105S2SS2FA 1U125S2SN1FA/B 1U125S2SN2FA/B 1U140S2SN1FA/B 1U140S2SP1FA/B 1U140S2SP2FA/B	Liquid pipe	$\Phi 9.52\text{mm}$	flaring connection
	Gas pipe	$\Phi 15.88\text{mm}$	
1U160S2SP1FB	Liquid pipe	$\Phi 9.52\text{mm}$	flaring connection
	Gas pipe	$\Phi 19.05\text{mm}$	

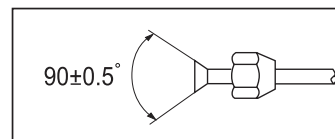

Install the removed flare nuts to the pipes to be connected, then flare the pipes.

7.3. Limitations for one way piping length and vertical height difference for single split

Model	1U105S2SS1FA/B 1U105S2SS2FA 1U125S2SN1FA/B 1U125S2SN2FA/B 1U140S2SN1FA/B	1U140S2SP1FA/B 1U140S2SP2FA/B 1U160S2SP1FB
One way piping length	less than 50 m	less than 75 m
Vertical height difference (between indoor and outdoor)	less than 30 m	less than 30 m

Precautions for refrigerant piping

- Do not twist or crush piping.
- Be sure that no dust is mixed in piping.
- Bend piping with as wide angle as possible.
- Keep insulating both gas and liquid piping.
- Check flare-connected area for gas leakage.

7.4. Piping connection method

- Apply refrigerant oil to the joint and the flange.
- To bend a pipe, give the roundness as possible not to crush the pipe.
- When connecting pipe, hold the pipe centre to centre and then screw nut on by hand, refer to Fig.
- Be careful not to let foreign matters, such as sands enter the pipe

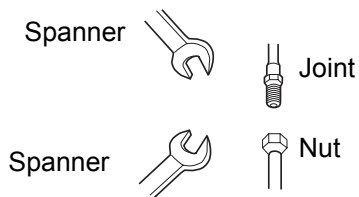

Pipe diameter	Fastening torque (N.m)
Liquid pipe Φ 6.35mm	14.2-17.2
Liquid pipe Φ 9.52mm	32.7-39.9
Gas pipe Φ 12.7mm	49.5-60.3
Gas pipe Φ 15.88mm	61.8-75.4
Gas pipe Φ 19.05mm	97.2-118.6

- Field pipes can be installed in four directions (A, B, C, D, E).

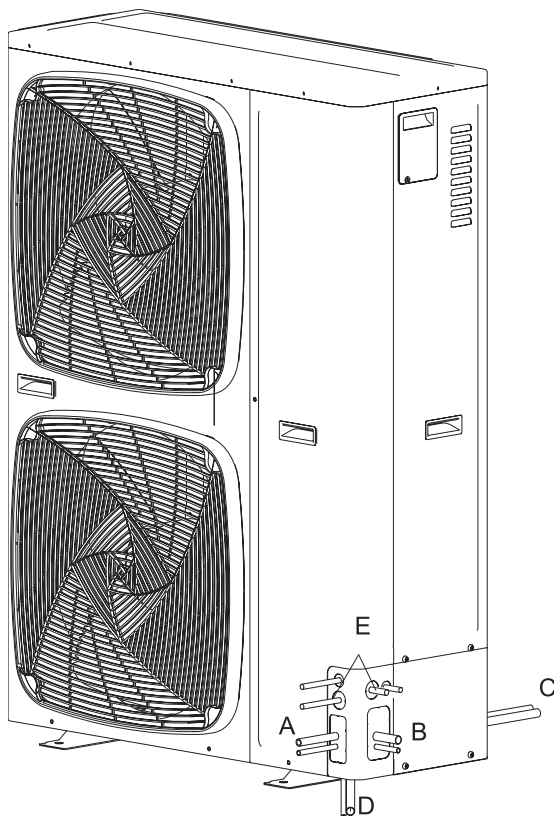

A: Forward

B: Sideways

C: Backward

D: Downward

E: Power supply cable outdoor and indoor connection cable

- Cutting out the two slits makes it possible to install as shown in the figure "Field pipes in 4 directions". (Use a metal saw to cut out the slits.)

- To install the connecting pipe to the unit in a downward direction, make a knock-out hole by penetrating the centre area around the knock-out hole using a Φ 6 mm drill (4x).

- After knocking out the knock-out hole, it is recommended to apply repair paint to the edge and the surrounding end surfaces to prevent rusting.
- When passing electrical wiring through the knock-out holes, remove any burrs from the know-out holes and wrap the wiring with protective tape to prevent damage.

7.5. Preventing foreign objects from entering

Plug the pipe through-holes with putty or insulating material (procured locally) to stop up all gaps, as shown in the figure.

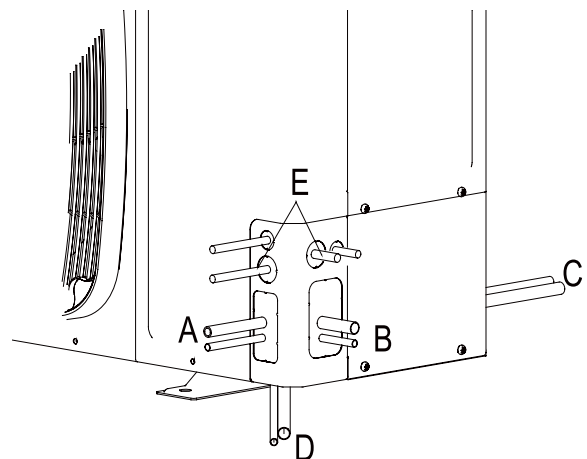

1 Putty or insulating material (produced locally)

If there is any possibility that small animals enter the system through the knock-out holes, plug the holes with packing materials (field supplied).

Insects or samall animals entering the outdoor unit may cause a short circuit in teh electrical box.

Seal knock-out holes to avoid snow and humidity entering.

7.6. Preventing foreign objects from entering

- Be careful not to let the indoor and outdoor piping come into contact with the compressor terminal cover.

If the liquid-side piping insulation might come into contact with it, adjust the height as shown in the figure below. Also, make sure the field piping does not touch the bolts or outer panels of the compressor.

- When the outdoor unit is installed above the indoor unit the following can occur:

The condensed water on the stop valve can move to the indoor unit. To avoid this, please cover the stop valve with sealing material.

- If the temperature is higher than 30 and the humidity is higher than RH 80, then thickness of the sealing materials should be at least 20mm in order to avoid condensation on the surface of the sealing.
- Be sure to insulate the liquid and gas-side field piping.



NOTICE

Any exposed piping may cause condensation.

(The highest temperature that the gas-side piping can reach is around 120°C, so be sure to use insulating material which is very resistant.)



DANGER

No not touch piping and internal parts.

7.7. Cautions for necessity of a trap

To avoid the the risk of oil held inside the riser piping flowing back into the compressor when stopped and causing liquid compression phenomenon, or cases of deterioration of oil return, it will be necessary to provide a trap at each difference in height of 10m in the riser gas piping.

- A trap is not necessary when the outdoor unit is installed at higher position than the indoor unit.

8. Leak test and vacuum drying

When all piping work is complete and the outdoor unit is connected to the indoor unit, it is necessary to :

- check for any leakages in the refrigerant piping
- to perform vacuum drying to remove all moisture in the refrigerant piping.

If there is a possibility of moisture being present in the refrigerant piping (for example, rainwater may have entered the piping), first carry out the vacuum drying procedure below until all moisture has been removed.

8.1. General guidelines

- All piping inside the unit has been factory tested for leaks.
- Use a 2-stage vacuum pump with a non-return valve which can evacuate to a gauge pressure of -100.7kPa(5 Torr absolute,-755mm Hg).
- Connect the vacuum pump to both the service port of the gas stop valve and the liquid stop valve to increase efficiency.



NOTICE

- Do not purge the air with refrigerants. Use a vacuum pump to evacuate the installation. No additional refrigerant is provided for air purging.

Make sure that the gas stop valve and liquid stop valve are firmly closed before performing the leak test or vacuum drying.

8.2. Leak test

The leak test must satisfy specification EN378-2.

1. Vacuum leak test
 - 1.1 Evacuate the system from the liquid and gas piping to -100.7 kPa(5 Torr).
 - 1.2 Once reached, turn off the vacuum pump and check that the pressure does not rise for at least 1 minute.
 - 1.3 Should the pressure rise, the system may either contain moisture (refer to the paragraph " Vacuum drying ") or have leaks.
2. Pressure leak test
 - 2.1 Break the vacuum by pressurizing with nitrogen gas to a minimum gauge pressure of 0.2 MPa (2 bar). Never set the gauge pressure higher than the maximum operation pressure of the unit, i.e. 4.0MPa (40bar).
 - 2.2 Test for leaks by applying a bubble test solution to all piping connections.



NOTICE

Make sure to use a recommended bubble test solution from your wholesaler.

Do not use soap water, which may cause cracking of false nuts (soap water may contain salt, which absorbs moisture that will freeze when the piping gets cold). and/or lead to corrosion of flared joints (soap water may contain ammonia which causes a corrosive effect between the brass flare nut and the copper flare).

8.3. Vacuum drying

To remove all moisture from the system, proceed as follows:

1. Evacuate the system for at least 2 hours to a target vacuum of -100.7 kPa(=-1.007 bar).
2. Check that, with the vacuum pump turned off, the target vacuum is maintained for at least 1 hour.
3. Should you fail to reach the target vacuum within 2 hours or maintain the vacuum for 1 hour, the system may contain too much moisture.
4. In that case, break the vacuum by pressurizing with nitrogen gas to a gauge pressure of 0.05 MPa (0.5bar) and repeat steps 1 to 3 until all moisture has been removed.
5. The stop valves can now be opened, and/or additional refrigerant can be charged.



INFORMATION

After opening the stop valve, it is possible that the pressure in the refrigerant piping does not rise. This might be caused by e.g. the closed state of the expansion valve in the outdoor unit circuit, but does not present any problem for correct operation of the unit.

9. Charging refrigerant

9.1 Important information regarding the refrigerant used

- This product contains fluorinated greenhouse gases covered by the **Kyoto Protocol**. Do not vent gases into the atmosphere.
- Evacuate Indoor Unit and interconnecting pipework to a vacuum pressure of 500 microns and hold for 15 minutes.
- The Outdoor unit is supplied with refrigerant HFC-410A (R410A) sufficient for 30m line length. Calculate additional refrigerant to suit your line length; refer supplied Specification Sheet.
- Open the service valve at the Outdoor unit to allow refrigerant to flow throughout the system.
- For long line lengths, oil (of the correct type) should be added to the refrigerant system at the rate shown in the Specification Data table. (see paragraph 9.5)
- Leak check all brazed and fitted joints.

9.2. Precautions and general guidelines

- When servicing the unit requires the refrigerant system to be opened, treatment and evacuation of refrigerant must be done in accordance with applicable legislation. Refrigerant can not be charged until field wiring has been completed.
- Refrigerant may only be charged after performing the leak test and vacuum drying.



CAUTION

When charging a system, care shall be taken that its maximum permissible charge is never exceeded, in view of the danger of liquid hammer.



WARNING

- Refrigerant cylinders shall be opened slowly.
- Always use protective gloves and protect your eyes when charging refrigerant.



DANGER

- When the power is on, please close the front panel when leaving the unit unattended.
Charging with an unsuitable substance may cause explosions and accidents, so always ensure that the appropriate refrigerant (R32) is charged.

- This unit requires additional charging of refrigerant according to the length of refrigerant piping connected at the site.
- Make sure to charge the refrigerant in liquid state to the liquid pipe. Since R410A is a mixed refrigerant, its composition changes if charged in its gaseous state and normal system operation would then no longer be assured.
- Before charging, check whether the refrigerant cylinder has a siphon attached or not and position the cylinder accordingly.

Fill using a cylinder with a siphon attached
Charge the liquid refrigerant with the cylinder in upright position.

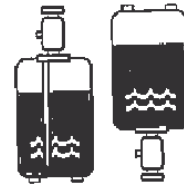

Fill using a cylinder with a siphon attached
Charge the liquid refrigerant with the cylinder in upside-down position.

On this model it is not necessary to charge additionally if the piping length ≤ 30 m.

9.3. Complete recharging



NOTICE

Before recharging, make sure to execute vacuum drying of the internal piping of the unit as well. To do so, use the internal service port of the unit. Do not use the service ports located on the stop valve, since vacuum drying can not be performed properly from these ports.

Outdoor units have 1 port on the piping. It is between the heat exchanger and the 4-way valve.

In case complete recharging is required (after a leak, etc.), refer to the information below to determine the necessary amount of refrigerant.



WARNING

Some sections of the refrigerant circuit may be isolated from other sections caused by components with specific functions (e.g. valves). The refrigerant circuit therefore features additional service ports for vacuuming, pressure relief or pressurizing the circuit. In case it is required to perform brazing on the unit, ensure that there is no pressure remaining inside the unit. Internal pressures need to be released with ALL the service ports indicated on the figures below opened. The location is depending on mode type.

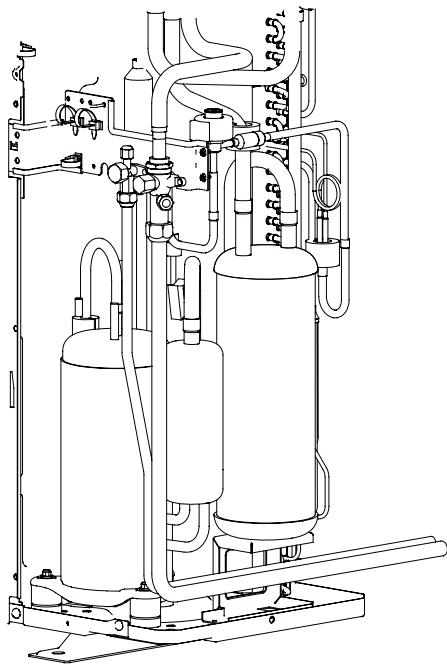

9.4 Total charging weight of the refrigerant (after a leak, etc.)

The total charging amounts relate to the refrigerant piping length.

Model	Refrigerant piping length (liquid side)							
	5-10m ^(a)	10-20m	20-30m	30-40m	40-50m	50-60m	60-70m	70-75m
1U105S2SS1FA/B 1U105S2SS2FA	1.7	1.7	1.7	2.15	2.6	-	-	-
1U125S2SN1FA/B	2.0	2.0	2.0	2.45	2.9	-	-	-
1U125S2SN2FA/B 1U140S2SN1FA/B	2.3	2.3	2.3	2.75	3.2	3.65	4.1	4.55
1U140S2SP1FA/B 1U140S2SP2FA	2.9	2.9	2.9	3.35	3.8	4.25	4.7	5.15
1U140S2SP2FB 1U160S2SP1FB	3.5	3.5	3.5	3.95	4.4	4.85	5.3	5.75

9.5 Add oil instruction

The cumout of oil added can be calculated by the following formula : $Q=(A+(L-30)*B)/4-C$

mode	factory refrigerant charge	recharge quantity	factory oil charging
	A(g)	B(g/m)	C(cc)
1U105S2SS1FA/B 1U105S2SS2FA	1700	45	800
1U125S2SN1FA/B	2000	45	870
1U125S2SN2FA/B 1U140S2SN1FA/B	2300	45	870
1U140S2SP1FA/B 1U140S2SP2FA	2900	45	1250
1U140S2SP2FB 1U160S2SP1FB	3500	45	150

Note:

- when $Q \leq 0$, oil added = 0;
- when $Q > 0$, oil added = Q (cc);
- L is the liquid pipe length, unit(m)

10. Electrical wiring work

WARNING

- All wiring must be performed by an authorized electrician.

All components procured on the side and all electric construction shall comply with the applicable legislation.

DANGER: HIGH VOLTAGE.

To avoid electrical shock, make sure to disconnect the power supply 1 minute or more before servicing the electrical parts. Even after 1 minute, always measure the voltage at the terminals of main circuit capacitors or electrical parts and, before touching, make sure that those voltages are 50VDC or less.

NOTICE

To persons in charge of electrical wiring work: Do not operate the unit until the refrigerant piping is complete. (Running it before the piping is ready will break the compressor.)

10.1. Precautions on electrical wiring work

- When servicing the unit requires the refrigerant system to be opened, treatment and evacuation of refrigerant must be done in accordance with applicable legislation. Refrigerant can not be charged until field wiring has been completed.

Refrigerant may only be charged after performing the leak test and vacuum drying.

DANGER

- Before obtaining access to terminal devices, all supply circuits must be interrupted.
- Be sure to install an earth leakage circuit breaker in accordance with applicable legislation. Failure to do so may cause electrical shock.
- Use only copperwires.
- A main switch or other means for disconnection, having a contact separation in all poles, must be incorporated in the fixed wiring in accordance with applicable legislation. Do not turn on the main switch until all the wiring is completed.
- Make sure to connect power supply cables in normal phase.
- Never squeeze bundled cables into a unit.
- Fix cables so that cables do not make contact with the pipes (especially on high pressure side).

- Secure the electrical wiring with cable ties as shown in the figure in 10.2 .
- Make sure no external pressure is applied to the terminal connectors.
- When installing the earth leakage circuit breaker make sure that it is compatible with the inverter (resistant to high frequency electrical noise) to avoid unnecessary opening of the earth leakage circuit breaker.
- As this unit is equipped with an inverter, installing a phase advancing capacitor not only will deteriorate power factor improvement effect, but also may cause capacitor abnormal heating accident due to high-frequency waves. Therefore, never install a phase advancing capacitor.



CAUTION

Be sure to install the required fuses or circuit breakers.

10.2. Connecting power supply and inter-unit wiring

- Connect and fix the power supply cable, indoor-outdoor connection cable as following:

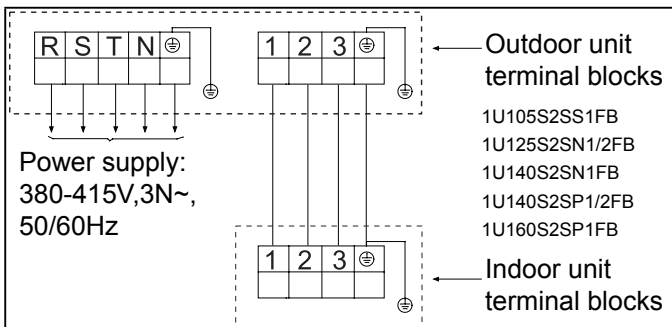

For three phase power supply models:
 1U105S2SS1FB 1U125S2SN1/2FB 1U140S2SN1FB
 1U140S2SP1/2FB 1U160S2SP1FB

Power supply cable:
 H05RN-F 5G 4mm²,

Indoor and outdoor connection cable:
 H05RN-F 4G 2.5mm² £n-1 Note £. If the indoor and outdoor unit connection cable length L satisfied condition 40m < L < 55m, please change the connection cables specification to H07RN-F 4G 4.0mm². If the indoor and outdoor unit connection cable length L satisfied condition 55m < L < 75m, please change the connection cables specification to H07RN-F 4G 6.0mm² £'

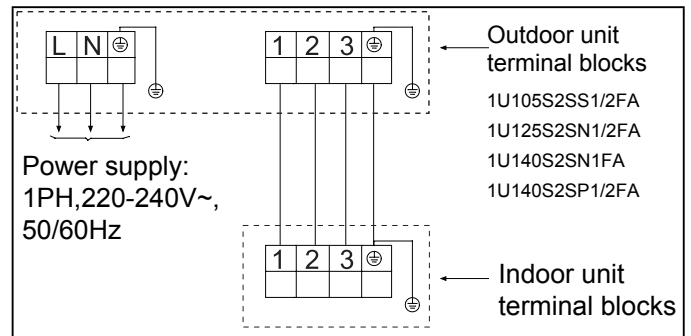

For single phase power supply models:
 1U105S2SS1FA, 1U105S2SS2FA,
 Power supply cable: H05RN-F 3G 4.0mm²
 1U125S2SN1FA, 1U125S2SN2FA, 1U140S2SP2FA,
 1U140S2SN1FA, 1U140S2SP1FA
 Power supply cable: H05RN-F 3G 6.0mm²
 Indoor and outdoor connection cable: H05RN-F 4G 2.5mm² £n-1 Note £. If the indoor and outdoor unit connection cable length L satisfied condition 40m < L < 55m, please change the connection cables specification to H07RN-F 4G 4.0mm². If the indoor and outdoor unit connection cable length L satisfied condition 55m < L < 75m, please change the connection cables specification to H07RN-F 4G 6.0mm² £'

- Fix the cable with the clip to prevent slide.

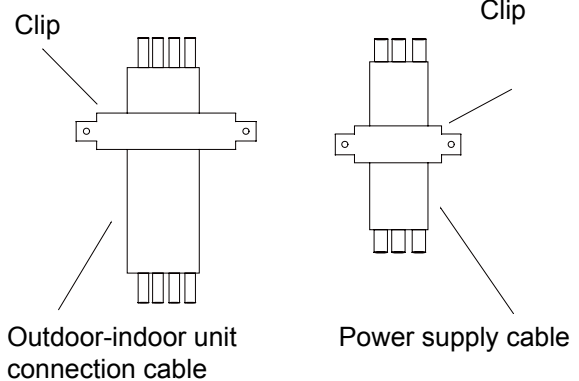

- Secure the cable to the stop valve attachment plate so that it does not slide.
- When cables are routed from the unit, a protection sleeve for the conduits (PG-insertions) can be inserted at the knock-out hole.
- When you do not use a wire conduit, be sure to protect the wires with vinyl tubes to prevent the edge of the knock-out hole from cutting the wires.
- Follow the electric wiring diagram for electrical wiring works.

- Form the wires and fix the cover firmly so that the cover may be fit in properly.
- When you do not use a wire conduit, be sure to protect the wires with vinyl tubes to prevent the edge of the knock-out hole from cutting the wires.
- Follow the electric wiring diagram for electrical wiring works.
- Form the wires and fix the cover firmly so that the cover may be fit in properly.
 - Do not connect wires of different gauge to the same power supply terminal. (Looseness in the connection may cause overheating.)
- Use the correct screwdriver to tighten the terminal screws. Small screwdrivers can damage the screw head and prevent appropriate tightening.
- Over-tightening the terminal screws can damage the screws.

10.3. Specifications of standard wiring components



CAUTION

- Select all cables and wire sizes in accordance with applicable legislation.
- After finishing the electrical work, confirm that each electric part and terminal inside the electric part box is connected securely.
- The earth leakage breaker must be a high-speed type breaker of 30 mA (<0.1 s).

11. Test operation



DANGER

Never leave the unit unattended during installation or servicing. When the service panel is removed live parts can be easily touched by accident.



INFORMATION

Note that during the first running period of the unit, required power input may be higher than stated on the nameplate of the unit. This phenomenon originates from the compressor that needs elapse of a 50 hours run in period before reaching smooth operation and stable power consumption.

11.1. Pre-run checks

Items to check	
Electrical wiring Inter-unit wiring Ground wire	<ul style="list-style-type: none"> ■ Is the wiring as mentioned on the wiring diagram? Make sure no wiring has been forgotten and that there are no missing phases or reverse phases. ■ Is the unit properly grounded? ■ Is the wiring between units connected in series correct? Are any of the wiring attachment screws loose? Is the insulation resistance at least 1 MΩ? - Use a 500V mega-tester when measuring insulation. - Do not use a mega-tester for low-voltage circuits.
Refrigerant piping	<ul style="list-style-type: none"> ■ Is the size of the piping appropriate? ■ Is the insulation material for the piping attached securely? Are both the liquid and gas pipes insulated? ■ Are the stop valves for both the liquid side and the gas side open?
Extra refrigerant	<ul style="list-style-type: none"> ■ Did you write down the extra refrigerant and the refrigerant piping length?

- Be sure to perform a test run.
- Be sure to fully open the liquid-side and gas-side stop valves. If you operate the unit with stop valves closed, the compressor will breakdown.
- Be sure to execute the first test run of the installation in cooling mode operation.
- Never leave the unit unattended with an open front panel during test run.

11.2. Precautions regarding test-runs

1. In order to detect stop valves failing to open, operation of the unit is compulsorily performed in cooling for 2-3 minutes during the first test run, even if the remote controller was set to heating operation. In this case, the remote controller will have kept displaying the heating symbol all the time and the unit will switch to heating operation automatically after elapse of that time.
2. In case you cannot operate the unit in test run mode for any unusual reason, refer to "**11.4. Failure diagnosis at the moment of first installation**".
3. In case of a wireless remote controller, execute the run only after having installed the indoor unit decoration panel with infrared receiver first.
4. In case the panels of indoor units are not yet installed to the indoor units, make sure to shut off the power supply after finishing the complete test run.
5. A complete test run surely includes shutting off power after having performed a normal operation stop on the remote controller. Do not stop operation by turning circuit breakers off.

11.3 Before Installing (Relocating) the Unit or Performing Electric Work

 CAUTION	
<p>Ground the unit.</p> <p>Do not connect the grounding on the unit to gas pipes, water pipes, lightning rods, or the grounding terminals of telephones. Improper grounding presents a risk of electric shock, smoke, fire, or the noise caused by improper grounding may cause the unit to malfunction.</p> <p>Make sure the wires are not subject to tension.</p> <ul style="list-style-type: none"> ■ If the wires are too taut, they may break or generate heat and/or smoke and cause fire. <p>Install a breaker for current leakage at the power source to avoid the risk of electric shock.</p> <ul style="list-style-type: none"> ■ Without a breaker for current leakage, there is a risk of electric shock, smoke or fire. <p>Use breakers and fuses (electrical current breaker, remote switch<switch+Type-B fuse>, molded case circuit breaker) with a proper current capacity.</p> <ul style="list-style-type: none"> ■ The use of large-capacity fuses, steel wire, or copper wire may damage the unit or cause smoke or fire. 	<p>Do not spray water on the air conditioners or immerse the air conditioners in water.</p> <ul style="list-style-type: none"> ■ Water on the unit presents a risk of electric shock. Periodically check the platform on which is placed for damage to prevent the unit from falling. ■ If the unit is left on a damaged platform, it may topple over, causing injury. <p>When installing draining pipes, follow the instructions in the manual, and make sure that they properly drain water so as to avoid dew condensation.</p> <ul style="list-style-type: none"> ■ If not installed properly, they may cause water leaks and damage the furnishings. <p>Properly dispose of the packing materials.</p> <ul style="list-style-type: none"> ■ Things such as nails may be included in the package. Dispose of them properly to prevent injury. ■ Plastic bags present a choking hazard to children. Tear up the plastic bags before disposing of them to prevent accidents.

Before the Test Run

 CAUTION	
<p>Do not operate switches with wet hands to avoid electric.</p> <p>Do not touch the refrigerant pipes with bare hands during and immediately after operation.</p> <ul style="list-style-type: none"> ■ Depending on the state of the refrigerant in the system, certain parts of the unit such as the pipes and compressor may become very cold or hot and may subject the person to frost bites or burning. <p>Do not operated the unit without panels and safety guards in their proper places.</p> <ul style="list-style-type: none"> ■ They are there to keep the users from injury from accidentally touching rotating, high-temperature or high-voltage parts. 	<p>Do not turn off the power immediately after stopping the unit.</p> <ul style="list-style-type: none"> ■ Allow for at least five minutes before turning off the unit, otherwise the unit may leak water or experience other problems. <p>Do not operate the unit without air filters.</p> <ul style="list-style-type: none"> ■ Dust particles in the air may clog the system and cause malfunction.

11.4. Failure diagnosis

OUTDOOR UNIT TROUBLE SHOOTING			
Error code	Malfunction Description	Diagnosis and Analysis.	Remark
1	EEPROM malfunction	EEPROM chip damaged or data wrong or related circuit damaged.	Non-resumable
2	PIM (power intelligent module) hardware over current	Input over current occurred been detected by PIM's hardware.	Resumable
3	Compressor over current during deceleration	Over current occurred during compressor deceleration period.	Non-resumable
4	Communication abnormal between control board and compressor driver module	Control board can not communicating with compressor driver module over 4 minutes	Resumable
5	Compressor overcurrent detected by control board	Compressor over current been detected by control board	Non-resumable
6	DC voltage or AC voltage high	AC power supply of the driver module get voltage over 280VAC or driver module get high DC-BUS voltage over 390VDC.	Resumable
7	Compressor current sampling circuit fault	The driver module's Compressor current sampling circuit damaged.	Non-resumable
8	Discharge temperature too high protection	Compressor discharge temperature over 115°C, error clear within 3 minutes if temperature goes down and lower than 115°C. Error status lock if it occurs 3 times in 1 hour.	Non-resumable
9	DC fan motor fault	DC fan motor damage or not connected or related circuit broken. Error status confirm and lock if occurs 3 times within 30 minutes.	Non-resumable
10	Outdoor defrosting temp, sensor Te abnormal	Sensor temperature been detected below -55°C or higher than 90°C or been detected as short circuit or open circuit..	Resumable
11	Suction temp.sensor Ts abnormal		
12	Outdoor ambient temp, sensor Ta abnormal	Sensor temperature been detected below -40°C or higher than 90°C or been detected short circuit or open circuit.	Resumable
13	Discharging temp, sensor Td abnormal	Sensor temperature been detected below -40°C or higher than 150°C or been detected short circuit or open circuit.	Resumable
14	PFC circuit loop high voltage	Overvoltage been detected in driver module's power factor correction circuit loop.	Resumable
15	Communication abnormal between indoor unit and outdoor unit	Outdoor unit control board can not communicating with indoor unit control board over 4 minutes.	Resumable
16	Lack of refrigerant or discharging pipe blocked	Discharge & suction temperature Td-Ts≥80°C after compressor started 10 minutes. Error status lock if it occurs 3 times in 1 hour.	Non-resumable
17	4-way vavle converse abnormal	Indoor pipe & indoor ambient temperature Tm-Tai≥5°C after compress- or started 10 minutes. Error status lock if it occurs 3 times in 1 hour.	Non-resumable
18	Compressor motor desynchronizing	Rotor desynchronizing occurred, caused by overload or load sharply fluctuating or compressor current sensor circuit abnormal or one of the inverter's gate drive signal missing.	Non-resumable

Error code	Malfunction Description	Diagnosis and Analysis	Remark
19	DC voltage or AC voltage low	AC power supply of the driver module get voltage lower than 155VAC or driver module get high DC-BUS voltage lower than 180VDC.	Resumable
20	Indoor pipe temperature too high protection	Indoor pipe temperature Tm over 63°C, error clear within 3 minutes if temperature goes down and lower than 52°C.	Resumable
21	Indoor pipe sensor temperature too low protection	Indoor pipe temperature too low,outdoor unit stop to prevent indoor heat exchange system icing and to prevent the indoor unit outlet air too low at the same time	Resumable
22	PFC circuit loop overcurrent	Overcurrent been detected in power factor correction circuit loop.	Resumable
23	Temperature too high for compressor driver module	Compressor driver module's PIM temperature over 90°C, Error stat-us lock if it occurs 3 times in 1 hour.	Non-resumable
24	Compressor start failure	Compressor start failure been detected by driver module.	Non-resumable
25	Input overcurrent of the drive module	Input current of the compressor drive module higher than 32A (double fan model) or 27A (single fan), Lock if it occurs 3 times in 1 hour.	Non-resumable
26	Lack phase of the drive module	Lack phase of the drive module's power supply.(three phase type)	Non-resumable
27	Input current sampling circuit fault	The driver module's input current sampling circuit damaged.	Resumable
28	No wiring of the compressor	No wiring between compressor and it's driver module.	Non-resumable
37	Compressor overcurrent detected by compressor driver module	Compressor phase U or V or W current over 27A (single phase model) or 19.1 A (single phase model) occured during non-rated period.	Resumable
38	Drive module's ambient temp, sensor abnormal	The temperature detected is not within the range of -25°C to 150 °C.	Resumable
39	Mid-condenser temp, sensor TC abnormal	The temperature detected is not within the range of -55°C to 90 °C.	Resumable
42	High pressure switch abnormal	After compressor running for 3 minutes, switch been detected open circuit for 30seconds, Error lock if it occurs 3 times in 1 hour.	Non-resumable
43	Low pressure switch abnormal	After compressor running for 3 minutes, switch been detected uncon-nected for 60seconds or unconnected for 30seconds at standby.	Non-resumable
44	Outdoor condenser temperatureTC too high protection	The maximum temperature value of Tc and Te is over 65 °C, Error lock if it occurs 3 times in 30 minutes.	Non-resumable
45	System low pressure protection	The minimum temperature value of indoor pipe Tm and outdoorTs is lower than-45 °C at cooling mode or minimum temperature value of outdoor Tc and outdoor Te is lower than-45 °C at heating mode.	Non-resumable

Note:

1. The outdoor control board's LED3 indicates the outdoor error code, for example, the error code 12, LED3 will display 12 and keep flashing.
2. NO-resumable means error will not clear unless: a. clean out the fault factor b. Cut the power supply off and reoffer again after point a achieved.
3. The indoor unit can also indictes the outdoor malfunction code too. Please refer to indoor unit manual to get the method.

12. Move and scrap the air conditioning

- When moving, to disassemble and re-install the air conditioning, please contact your dealer for technical support.
- In the composition material of air conditioning, the content of lead, mercury, hexavalent chromium, polybrominated biphenyls and polybrominated diphenyl ethers are not more than 0.1% (mass fraction) and cadmium is not more than 0.01% (mass fraction).
- Please recycle the refrigerant before scrapping, moving, setting and repairing the air conditioning; for the air conditioning scrapping, should be dealt with by the qualified enterprises.



Haier

Qingdao Haier Air Conditioner Electric Co., Ltd

Address: Haier Industrial Park, Qianwangang Road, Eco-Tech Development Zone, Qingdao 266555,
Shandong, P.R.C. Contacts: TEL +86-532-88936943; FAX +86-532-8893-6999

Website: www.haier.com